



Daffodil Institute of IT

Moumita Akter

Lecture, Dept. of CSE

Daffodil Institute of IT (DIIT).

Introduction to Finite Automata

Languages

Deterministic Finite Automata

Representations of Automata

Alphabets

- ▶ An *alphabet* is any finite set of symbols.
- ▶ **Examples:** ASCII, Unicode, $\{0,1\}$ (*binary alphabet*), $\{a,b,c\}$.

Strings

- ▶ The set of *strings* over an alphabet Σ is the set of lists, each element of which is a member of Σ .
 - ▶ Strings shown with no commas, e.g., abc.
- ▶ Σ^* denotes this set of strings.
- ▶ ϵ stands for the *empty string* (string of length 0).

Example: Strings

- ▶ $\{0,1\}^* = \{\epsilon, 0, 1, 00, 01, 10, 11, 000, 001, \dots\}$
- ▶ **Subtlety:** 0 as a string, 0 as a symbol look the same.
 - ▶ Context determines the type.

Languages

- ▶ A *language* is a subset of Σ^* for some alphabet Σ .
- ▶ **Example:** The set of strings of 0's and 1's with no two consecutive 1's.
- ▶ $L = \{\epsilon, 0, 1, 00, 01, 10, 000, 001, 010, 100, 101, 0000, 0001, 0010, 0100, 0101, 1000, 1001, 1010, \dots\}$

Hmm... 1 of length 0, 2 of length 1, 3, of length 2, 5 of length 3, 8 of length 4. I wonder how many of length⁶ 5?

Deterministic Finite Automata

- ▶ A formalism for defining languages, consisting of:
 1. A finite set of *states* (Q , typically).
 2. An *input alphabet* (Σ , typically).
 3. A *transition function* (δ , typically).
 4. A *start state* (q_0 , in Q , typically).
 5. A set of *final states* ($F \subseteq Q$, typically).
 - ◆ “Final” and “accepting” are synonyms.

The Transition Function

- ▶ Takes two arguments: a state and an input symbol.
- ▶ $\delta(q, a)$ = the state that the DFA goes to when it is in state q and input a is received.

Graph Representation of DFA's

- ▶ Nodes = states.
- ▶ Arcs represent transition function.
 - ▶ Arc from state p to state q labeled by all those input symbols that have transitions from p to q .
- ▶ Arrow labeled “Start” to the start state.
- ▶ Final states indicated by double circles.

Example: Graph of a DFA

Accepts all strings without two consecutive 1's.

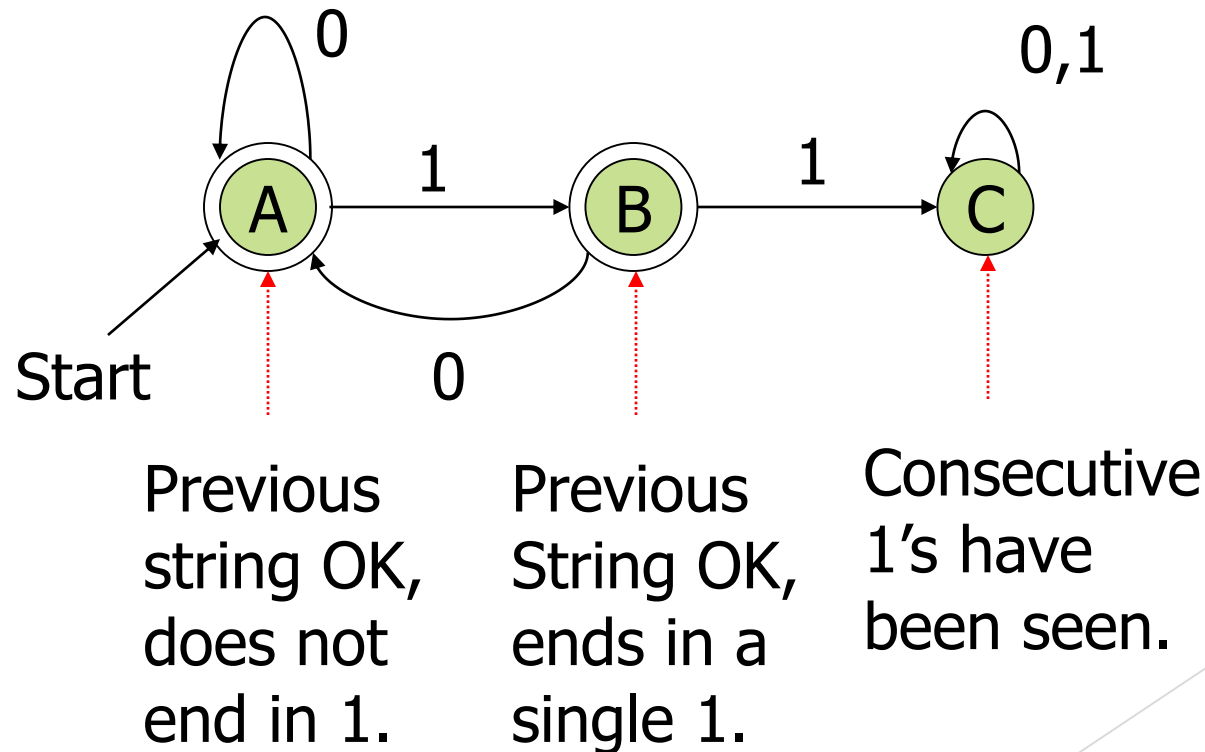

Alternative Representation: Transition Table

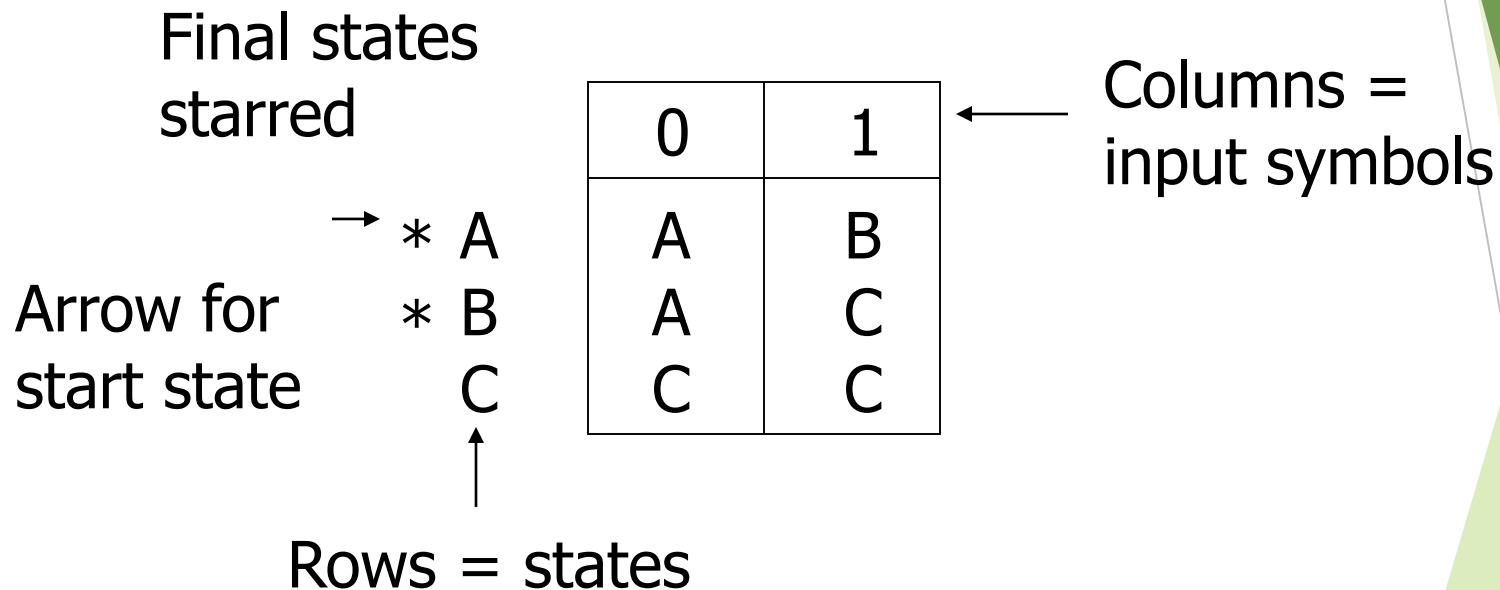

Extended Transition Function

- ▶ We describe the effect of a string of inputs on a DFA by extending δ to a state and a string.
- ▶ Induction on length of string.
- ▶ **Basis:** $\delta(q, \epsilon) = q$
- ▶ **Induction:** $\delta(q, wa) = \delta(\delta(q, w), a)$
 - ▶ w is a string; a is an input symbol.

Extended δ : Intuition

- ▶ **Convention:**
 - ▶ ... w, x, y, x are strings.
 - ▶ a, b, c, \dots are single symbols.
- ▶ Extended δ is computed for state q and inputs $a_1a_2\dots a_n$ by following a path in the transition graph, starting at q and selecting the arcs with labels a_1, a_2, \dots, a_n in turn.

Example: Extended Delta

	0	1
A	A	B
B	A	C
C	C	C

$$\delta(B,011) = \delta(\delta(B,01),1) = \delta(\delta(\delta(B,0),1),1) =$$
$$\delta(\delta(A,1),1) = \delta(B,1) = C$$

Delta-hat

- ▶ In book, the extended δ has a “hat” to distinguish it from δ itself.
- ▶ Not needed, because both agree when the string is a single symbol.
- ▶ $\hat{\delta}(q, a) = \delta(\hat{\delta}(q, \epsilon), a) = \delta(q, a)$

^

^



Extended deltas

Language of a DFA

- ▶ Automata of all kinds define languages.
- ▶ If A is an automaton, $L(A)$ is its language.
- ▶ For a DFA A , $L(A)$ is the set of strings labeling paths from the start state to a final state.
- ▶ Formally: $L(A) =$ the set of strings w such that $\delta(q_0, w)$ is in F .

Example: String in a Language

String 101 is in the language of the DFA below.
Start at A.

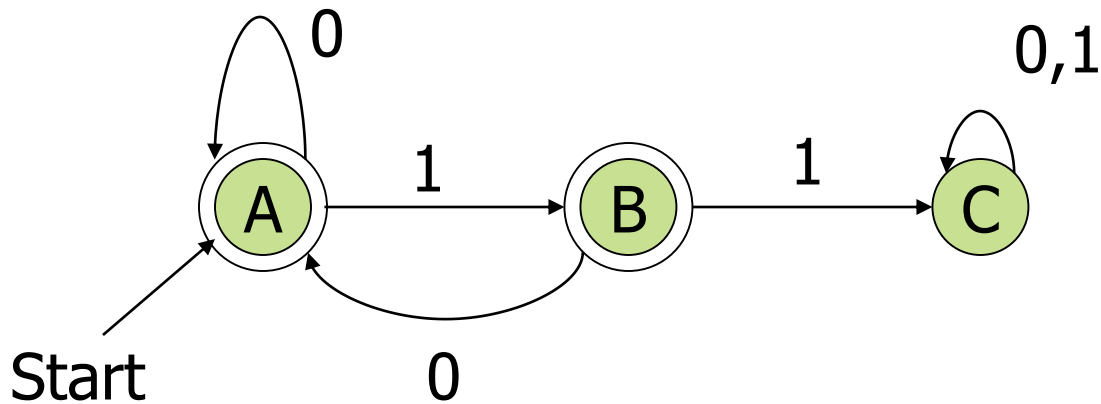

Example: String in a Language

String 101 is in the language of the DFA below.

Follow arc labeled 1.

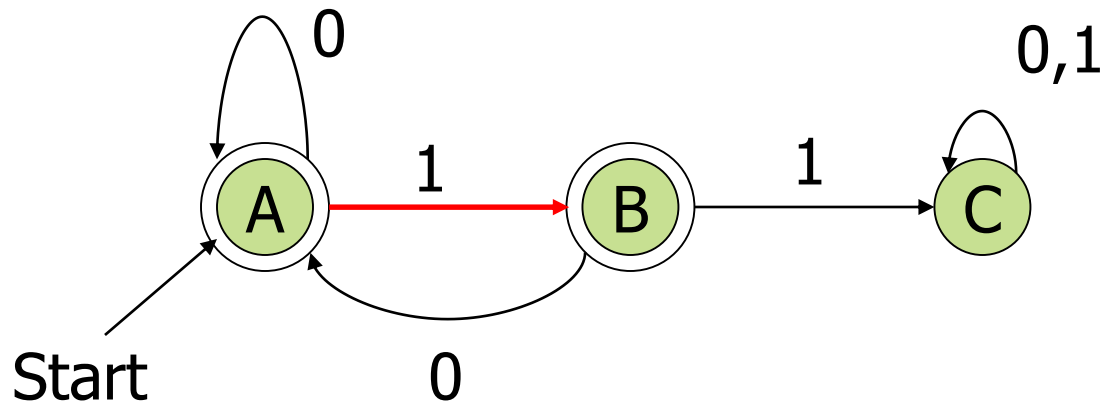

Example: String in a Language

String 101 is in the language of the DFA below.

Then arc labeled 0 from current state B.

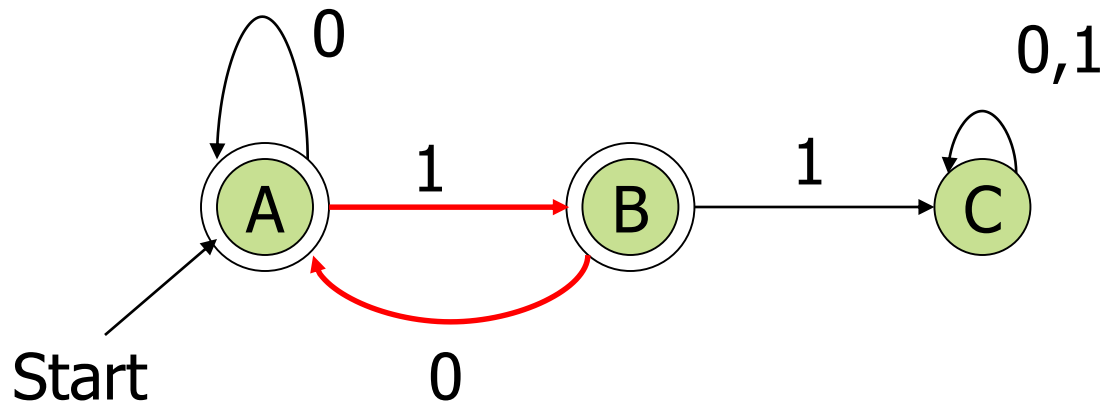

Example: String in a Language

String 101 is in the language of the DFA below.

Finally arc labeled 1 from current state A. Result is an accepting state, so 101 is in the language.

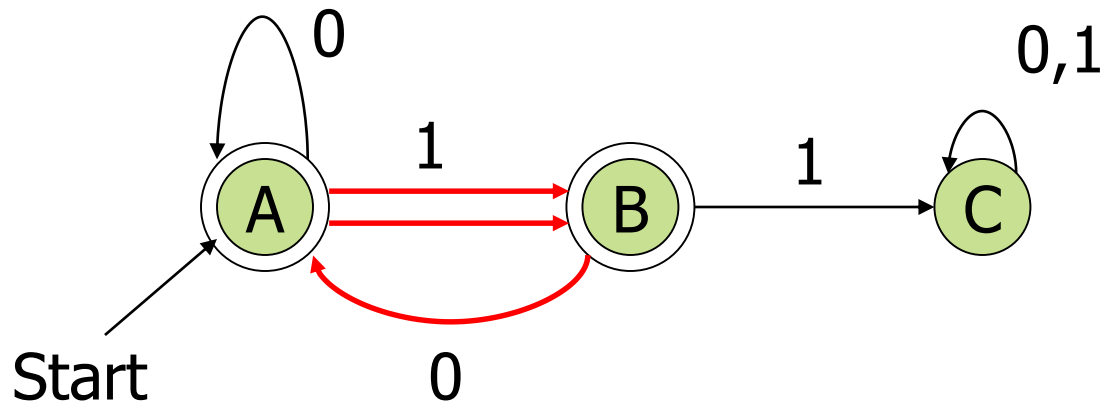

Example - Concluded

- ▶ The language of our example DFA is:
 $\{w \mid w \text{ is in } \{0,1\}^* \text{ and } w \text{ does not have}$

two consecutive 1's}

Such that...

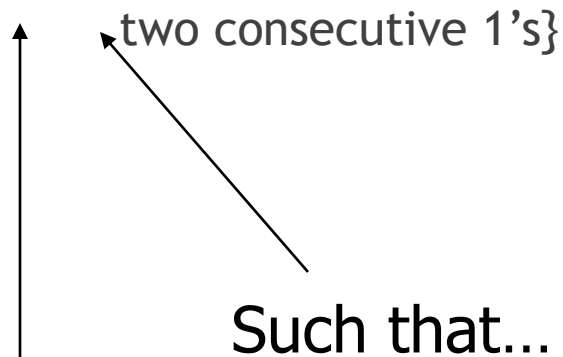

These conditions
about w are true.

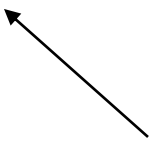

Read a *set former* as
"The set of strings w ..."

Proofs of Set Equivalence

- ▶ Often, we need to prove that two descriptions of sets are in fact the same set.
- ▶ Here, one set is “the language of this DFA,” and the other is “the set of strings of 0’s and 1’s with no consecutive 1’s.”

Proofs - (2)

- ▶ In general, to prove $S=T$, we need to prove two parts: $S \subseteq T$ and $T \subseteq S$. That is:
 1. If w is in S , then w is in T .
 2. If w is in T , then w is in S .
- ▶ As an example, let S = the language of our running DFA, and T = “no consecutive 1’s.”

Part 1: $S \subseteq T$

- ▶ **To prove:** if w is accepted by then w has no consecutive 1's.
- ▶ Proof is an induction on length of w .
- ▶ **Important trick:** Expand the inductive hypothesis to be more detailed than you need.

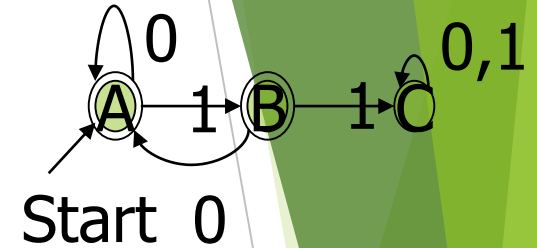

The Inductive Hypothesis

1. If $\delta(A, w) = A$, then w has no consecutive 1's and does not end in 1.
 2. If $\delta(A, w) = B$, then w has no consecutive 1's and ends in a single 1.
- ▶ **Basis:** $|w| = 0$; i.e., $w = \epsilon$.
- ▶ (1) holds since ϵ has no 1's at all.
 - ▶ (2) holds *vacuously*, since $\delta(A, \epsilon)$ is not B.

"length of"



Important concept:

If the "if" part of "if..then" is false, the statement is true.



Inductive Step

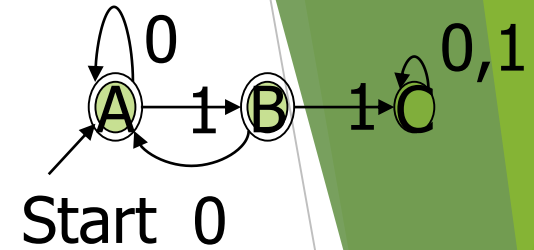

- ▶ Assume (1) and (2) are true for strings shorter than w , where $|w|$ is at least 1.
- ▶ Because w is not empty, we can write $w = xa$, where a is the last symbol of w , and x is the string that precedes.
- ▶ IH is true for x .

Inductive Step - (2)

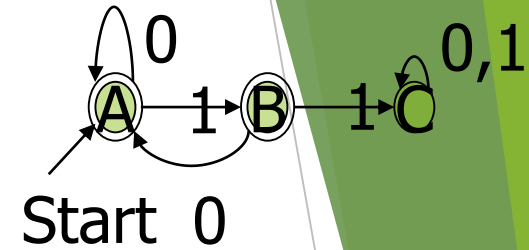

- ▶ Need to prove (1) and (2) for $w = xa$.
- ▶ (1) for w is: If $\delta(A, w) = A$, then w has no consecutive 1's and does not end in 1.
- ▶ Since $\delta(A, w) = A$, $\delta(A, x)$ must be A or B, and a must be 0 (look at the DFA).
- ▶ By the IH, x has no 11's.
- ▶ Thus, w has no 11's and does not end in 1.

Inductive Step - (3)

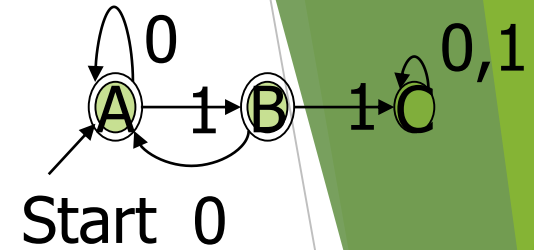

- ▶ Now, prove (2) for $w = xa$: If $\delta(A, w) = B$, then w has no 11's and ends in 1.
- ▶ Since $\delta(A, w) = B$, $\delta(A, x)$ must be A, and a must be 1 (look at the DFA).
- ▶ By the IH, x has no 11's and does not end in 1.
- ▶ Thus, w has no 11's and ends in 1.

Part 2: $T \subseteq S$

- ▶ Now, we must prove: if w has no 11's, then w is accepted by

- ▶ **Contrapositive**: If w is not accepted by

Start 0

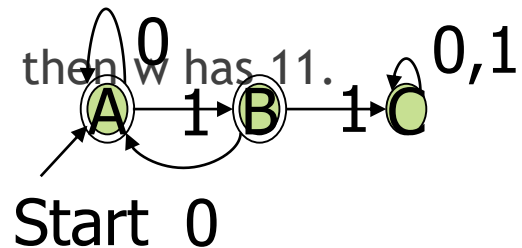

Key idea: contrapositive of "if X then Y " is the equivalent statement "if not Y then not X ."

Using the Contrapositive

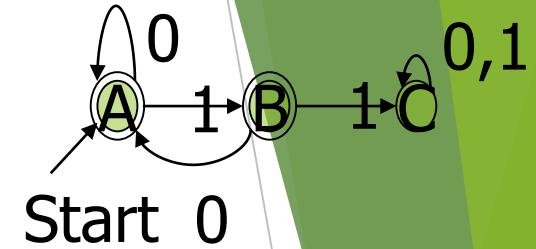

- ▶ Every w gets the DFA to exactly one state.
 - ▶ Simple inductive proof based on:
 - ▶ Every state has exactly one transition on 1, one transition on 0.
- ▶ The only way w is not accepted is if it gets to C.

Using the Contrapositive - (2)

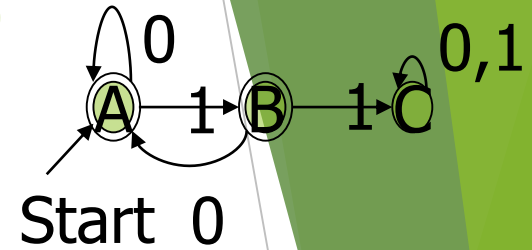

- ▶ The only way to get to C [formally: $\delta(A,w) = C$] is if $w = x1y$, x gets to B, and y is the tail of w that follows what gets to C for the first time.
- ▶ If $\delta(A,x) = B$ then surely $x = z1$ for some z .
- ▶ Thus, $w = z11y$ and has 11.

Regular Languages

- ▶ A language L is *regular* if it is the language accepted by some DFA.
 - ▶ **Note:** the DFA must accept *only* the strings in L , no others.
- ▶ Some languages are not regular.
 - ▶ Intuitively, regular languages “cannot count” to arbitrarily high integers.

Example: A Nonregular Language

$$L_1 = \{0^n 1^n \mid n \geq 1\}$$

- ▶ **Note:** a^i is conventional for i a 's.
 - ▶ Thus, $0^4 = 0000$, e.g.
- ▶ **Read:** “The set of strings consisting of n 0's followed by n 1's, such that n is at least 1.
- ▶ Thus, $L_1 = \{01, 0011, 000111, \dots\}$

Another Example

$L_2 = \{w \mid w \text{ in } \{(,)\}^* \text{ and } w \text{ is } \textit{balanced} \}$

- ▶ **Note:** alphabet consists of the parenthesis symbols '(' and ')'.
▶ Balanced parens are those that can appear in an arithmetic expression.
 - ▶ E.g.: (), (()), (()), (()),...

But Many Languages are Regular

- ▶ Regular Languages can be described in many ways, e.g., regular expressions.
- ▶ They appear in many contexts and have many useful properties.
- ▶ **Example:** the strings that represent floating point numbers in your favorite language is a regular language.

Example: A Regular Language

$L_3 = \{ w \mid w \text{ in } \{0,1\}^* \text{ and } w, \text{ viewed as a binary integer is divisible by } 23\}$

► The DFA:

- 23 states, named 0, 1, ..., 22.
- Correspond to the 23 remainders of an integer divided by 23.
- Start and only final state is 0.

Transitions of the DFA for L_3

- ▶ If string w represents integer i , then assume $\delta(0, w) = i\%23$.
- ▶ Then $w0$ represents integer $2i$, so we want $\delta(i\%23, 0) = (2i)\%23$.
- ▶ Similarly: $w1$ represents $2i+1$, so we want $\delta(i\%23, 1) = (2i+1)\%23$.
- ▶ **Example:** $\delta(15,0) = 30\%23 = 7$; $\delta(11,1) = 23\%23 = 0$.

Key idea: design a DFA by figuring out what each state needs to remember about the past.

Another Example

$L_4 = \{ w \mid w \text{ in } \{0,1\}^* \text{ and } w, \text{ viewed as the reverse of a binary integer is divisible by } 23\}$

- ▶ **Example:** 01110100 is in L_4 , because its reverse, 00101110 is 46 in binary.
- ▶ Hard to construct the DFA.
- ▶ But theorem says the reverse of a regular language is also regular.